

Table of Content

Introduction

Practice Before Operating	2
---------------------------------	---

Safety Instructions

Safety Considerations	4
Driving Outdoors	7
Driving on Various Terrains	9

Familiarize Yourself With Your Powerbase Wheelchair

Feature Diagram	11
Specification	12
Dismantled	13
Terminology	14
Disassembly the Powerbase Wheelchair	15

Adjusting For Comfort

Armrest Adjustment	16
Seat Height Adjustment	16
Footplate Angle Adjustment	17
Footplate Height Adjustment	17
Joystick Adjustment	17

Operating Your Powerbase Wheelchair

Manual Freewheel Levers	18
P&G VSI Controlle Operation	19
Batteries and Charging	24

Ice Symbols	27
-------------------	----

Warranty

Limited Warranty	28
------------------------	----



Welcome aboard your new powerbase wheelchair, and thank you for choosing our product. Please read this manual carefully, and follow all instructions before attempting to operate your powerbase wheelchair for the first time. If there is anything in this manual that you do not understand, or if you require additional assistance for setting up your powerbase wheelchair, Please contact your local dealer.

This latest model is designed for specific practical user needs, combining solid, rugged construction, and modern high-tech electronics, to enhance safety and performance.

With a state-of-the-art, programmable electronic control system, your powerbase wheelchair can be programmed and adjust within a given range of its performance characteristics, to suit your individual needs. The controller is set up at the factory to give the powerbase wheelchair nominal operating performance characteristics.

After becoming familiar with the basic operation of the powerbase wheelchair, you may wish to customize the settings to fit your own personal preferences. A wide range of customization options can be adjusted such as acceleration, deceleration, maximum speed, turning speed, safety controls, better maneuverability of the joystick, and so on. Contact your local dealer for advice on additional equipment you may need.

Have your powerbase wheelchair checked regularly by your local dealer is the best way to ensure smooth operation, and safety.

This manual provides users practical tips and information on safety issues, operation, and maintenance. Please read it very carefully to ensure your maximum enjoyment and to fully benefit from your independence and mobility.

Whenever special advice or attention is needed, please do not hesitate to contact your local dealer, who has the tools and know-how to provide expert servicing for your powerbase wheelchair.

Your satisfaction and opinions are highly valued by both your local dealer and our company. Please be sure to fill out the enclosed guarantee form, and return it to your local dealer. The information is necessary for providing you with the best service, and to be sure all of your needs are met.

Failure to follow these instructions may result in damage to the powerbase wheelchair or serious injury.

■ Practice Before Operating

Find an open area such as a park and have an assistant to help you practice until you have confidence operating this vehicle.

Make sure that the power is off before getting in or out of the seat. Set the speed control button according to your driving ability.

We recommend that you keep the speed control at the slowest position until you are familiar with the driving characteristics of this vehicle.

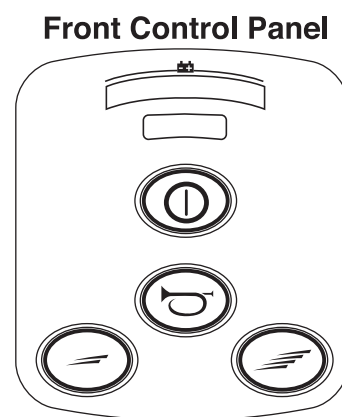
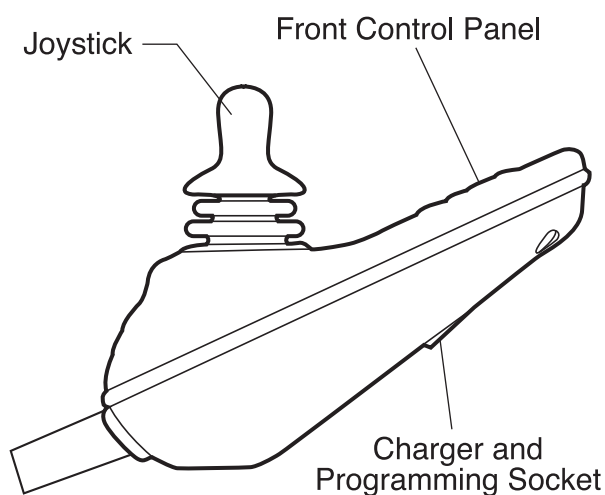
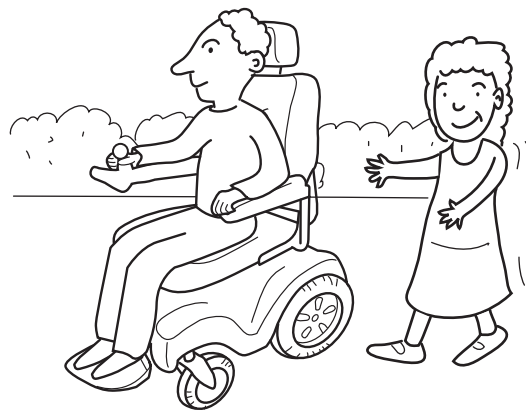

Refer to page 20 for an explanation of the various Control Panel functions

Getting familiar with this vehicle

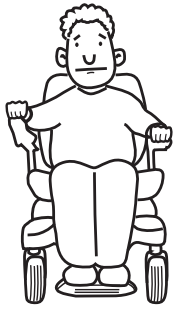

**First, practice moving forward.
Be sure to set the speed to the lowest setting.**



**After becoming familiar with moving forward,
practice marking "S" turns.**



**Once you are familiar with "S" turns, practice
moving in reverse. Note that any speed control
setting, the vehicle moves more slowly in reverse
than forward**

■ Safety Considerations

DO NOT do any of the following



NO!

Do not carry any passengers



NO!

Do not drive across a slope



NO!

Do not drink and drive
Consult your physician to
determine if your medications
impair your ability to control this
vehicle



NO!

Do not tow a trailer



NO!

Do not turn on or use hand-held personal
communication devices such as citizens band(CB)
radios and cellular phones

This vehicle has an immunity level of 30 v/m which should protect it from Electromagnetic Interference(EMI) from radio wave sources. The rapid development of electronics, especially in the area of communications, has saturated our environment with electromagnetic (radio) waves that are emitted by television, radio and communication signals. These EM waves are invisible and their strength increases as one approaches the source. All electrical conductors act as antennas to the EM signals and, to varying degrees, all power wheelchairs and power scooters are susceptible to electromagnetic interference (EMI). This interference could result in abnormal, unintentional movement and/or erratic control of the vehicle. The United Statement be incorporated to the user's manual for all electric power wheelchairs:

Powered wheelchairs and electric power scooters (in this text, both will be referred to as powered wheelchairs) may be susceptible to electromagnetic interference (EMI), which is interfering electromagnetic energy emitted from sources such as radio stations, TV stations, amateur radio (HAM) transmitters, two-way radios and cellular phones. The interference (from radio wave sources) can cause the powered wheelchair to release its brakes, move by itself or move in unintended directions. It can also permanently damage the powered wheelchair's control system. The intensity of the EM energy can be measured in volts per meter(V/m). Each powered wheelchair can resist EMI up to a certain intensity. This is called the "immunity level." The higher the immunity level, the greater the protection. At this time, current technology is capable of providing at least 30 V/m of immunity level which would provide useful protection against common sources of radiated EMI.

Following the warnings listed below should reduce the chance of unintended brake release or powered wheelchair movement that could result in serious injury:

- 1) Do not turn on hand-held personal communication devices such as citizens band (CB) radios and cellular phones while the powered wheelchair is turned on.
- 2) Be aware of nearby transmitters such as radio or TV stations and try to avoid coming close to them.

- 3) If unintended movement or brake release occurs, turn the powered wheelchair off as soon as it is safe.
- 4) Be aware that adding accessories or components, or modifying the powered wheelchair, may make it more susceptible to interference from radio wave sources. (Note: there is no easy way to evaluate their effect on the overall immunity of the powered wheelchair).
- 5) Report all incidents of unintended movement or brake release to the powered wheelchair manufacturer, and note whether there is a radio wave source nearby.

TURN OFF YOUR POWER WHEELCHAIR AS SOON AS POSSIBLE WHEN EXPERIENCING ANY OF THE FOLLOWING:

1. Unintentional motions.
2. Unintended or uncontrollable direction.
3. Unexpected brake release.

The FDA has written to the manufacturers of power wheelchairs, asking them to test their new products to be sure they provide a reasonable degree of immunity against EMI. The letter says that powered wheelchair should have an immunity level of at least 30 V/m, which provide a reasonable degree of protection against the more common sources of EMI. The higher the level, the greater the protection.

■ Driving Outdoors

When you are on the road, please pay attention to the following:



NO!

Do not drive in traffic.



NO!

Do not drive beside a river, port, or lake without a fence or railing.



NO!

If possible, do not drive during the rain.



NO!

If possible, do not drive during or on snow.



NO!

Do not drive off-road or on any uneven surfaced roads.



NO!

If possible, do not drive at night.

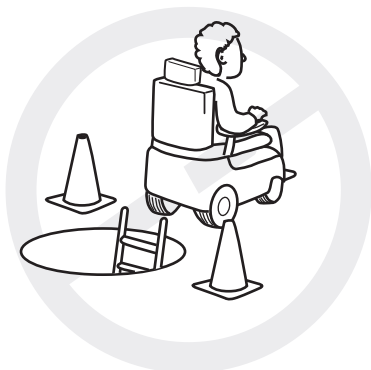

NO!

Make sure that there are no obstacles behind you when in reverse.

We recommend to set up the speed at the lowest setting for reversing.



NO!

Do not make sudden stops, weave erratically, or make sharp turns.



NO!

Keep your arms on or inside the armrests and feet on the footrest at all time.

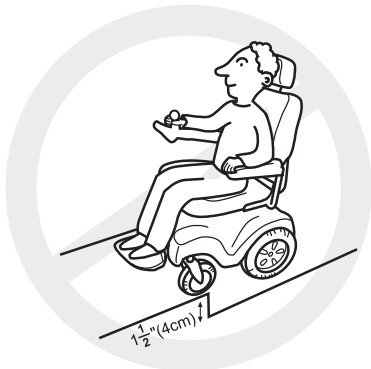

NO!

Do not attempt to climb curbs greater than 1 1/2" (4cm).

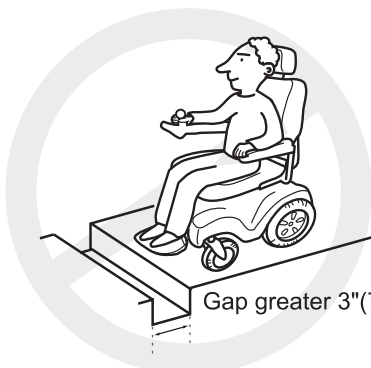

NO!

Do not attempt to cross over a gap greater than 3" (7.5cm).

Gap greater 3" (7.5cm)

■ Diving on Various Terrains

Driving on hills is more dangerous than on level surfaces. If you fail to heed these warnings, a fall, tip-over or loss of control may occur and cause severe injury to the vehicle user or others.



NO!

Do not attempt to climb a hill greater than 6°



NO!

Do not reverse while driving up a hill.

Forward only. If you reverse while moving up a hill, it may cause the vehicle to tip over.



NO!

Do not attempt to drive across a sloping surface greater than 3°

Driving across a slope greater than 3° is very dangerous and may cause the vehicle to tip over.



NO!

Do not drive over soft, uneven or unprotected surfaces such as grass, gravel and decks.

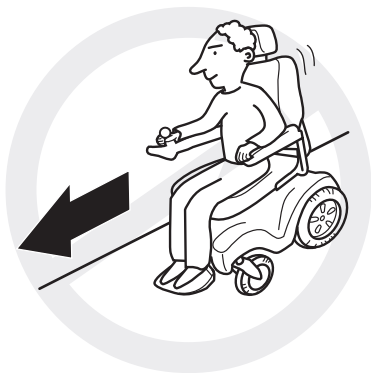

NO!

Use low speed while driving down hill.

When braking while moving down hill, the wheelchair will take longer to come to a complete stop.



NO!

Do not get on and off on a hill.

Always stop on the level surface to get in and get out of the vehicle.

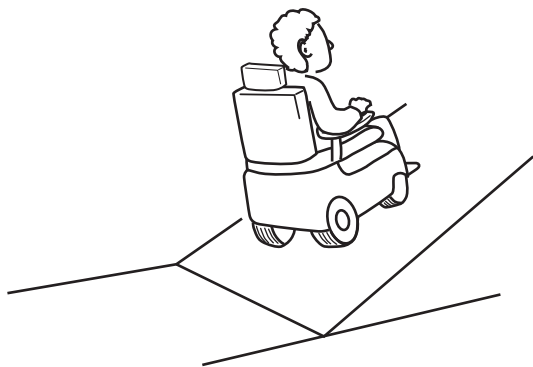

YES!

Always climb or descend gradients perpendicular to the slope or ramp.

Familiarize yourself with your powerbase wheelchair

■ **Feature Diagram**

In this section, we will acquaint you with the many features of your powerbase wheelchair and how they work. Upon receipt of your powerbase wheelchair, inspect it for any damage. Your powerbase wheelchair consists of the following components.



- 1. JOYSTICK
- 2. CONTROLLER
- 3. SEAT
- 4. FRONT SHROUD
- 5. FOOTREST
- 6. CASTER WHEEL

- 7. MANUAL FREEWHEEL LEVER
- 8. DRIVE WHEEL
- 9. ANTI-TIP WHEELS
- 10. REAR SHROUD
- 11. ARMRESTS

■ Micro Compact Powerbase Wheelchair Specifications



Model No.	P321	P321A
Length	33.9"(86cm)	
Width	21.5"(54.5cm)	
Seat Width	18"(46cm)	
Seat Height(from deck)	13.4"-17"(34-43.5cm)	
Seat Height(from ground)	18.7"-20.7"(47.5-52.5cm)	
Speed	4mph/6.4kph	
Range	6mi/9.6km	9mi/14km
Weight Capacity	250lbs (114kg)	
Total Weight(without battery)	108lbs (49kg)	
Motor	DC 24V/90W	
Brake	Intelligent, regenerative, electromagnetic brake	
Controller	P&G VSI 50A	
Battery	10AH * 2pcs	15AH * 2pcs
Charger	1.5A off board Max Lncline	
Gradient	6°	
Caster Wheel	6" solid tire	
Drive Wheel	8" solid tire	

■ P321 Dismantled

- 1.Front Section
- 2.Rear Section
- 3.Seat



■ Terminology

Joystick: The device used to "move" the powerbase wheelchair.

Controller: The device that allow joysticks to function. Not all joysticks have a controller.

Armrests: Where arms can rest during time spent on powerbase wheelchair.

Footrest: Where feet rest during time spent on the powerbase wheelchair.

Drive Wheel: The wheels that move the powerbase wheelchair. These are the main wheels.

Caster Wheel: The front wheels.

Controller Harness : Cable connecting the joystick to the controller.

Freewheel Lever: For convenience, your powerbase wheelchair is equipped with freewheel levers. These levers allow you to disengage the drive motors and maneuver the chair manually.



WARNING: DO NOT use the powerbase wheelchair without the presence of an attendant while the drive motors are disengaged! **DO NOT** disengage the drive motors when your powerbase wheelchair is on an incline, as the chair could roll down on its own, causing injury!

Note: It is important to remember that when the powerbase wheelchair is in the freewheel mode, the braking system is disengaged.

■ Disassembly the Powerbase wheelchair

Dismantled Procedure:

(a) Disconnect the controller plug.(Fig A)



Fig A

(b) Lift seat up directly.(Fig B)



Fig B

(c) Push the release button then dismantle the front and rear section.(Fig C)

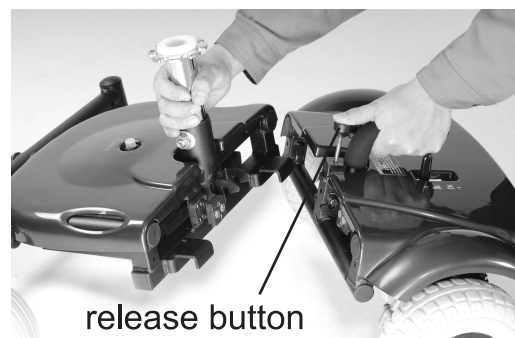

Fig C

Breaker button

The breaker button will jump up when circuit is short.

Push the button again, the powerchair will be reset.

Remark:

Connet your agency if the button jump up immediately after pushing the button.
(Fig D)



Fig D

Armrest adjustment

(a) Height adjustment

Loosen the knob "A" and adjust the armrest to right height then tight again.

(b) Width adjustment

Loosen knob "B" and adjust the armrest to right width then tight again.

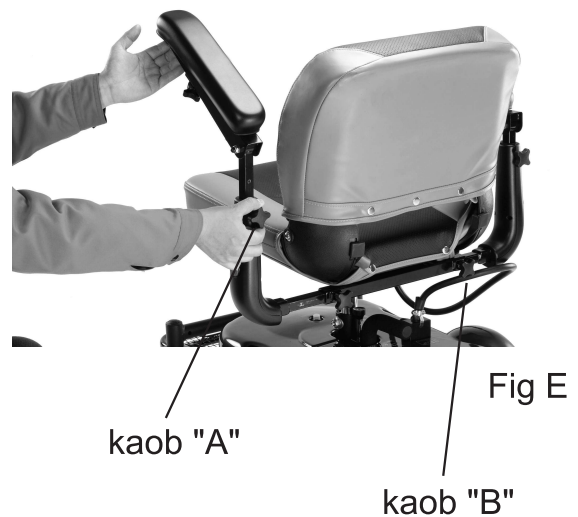

(c) Angle adjustment

(1) Flip up the armrest for easy access.

(2) Turn the set screw counter-clockwise to raise the armrest and clockwise to lower the armrest.(Fig E)

Seat Height Adjustment:

(1) Hold hexagonal screw by 17mm wrench (LH) and loosen the nut (RH).

(2) Choice the right height and tighten the bolt.(Fig F)



Footplate angle adjustment:

- (1) Flip-up the footplate for easy access.
- (2) With an allenkey and wrench, simply turn the bolt clockwise to increase the angle or counter-clockwise to decrease it.(Fig G)

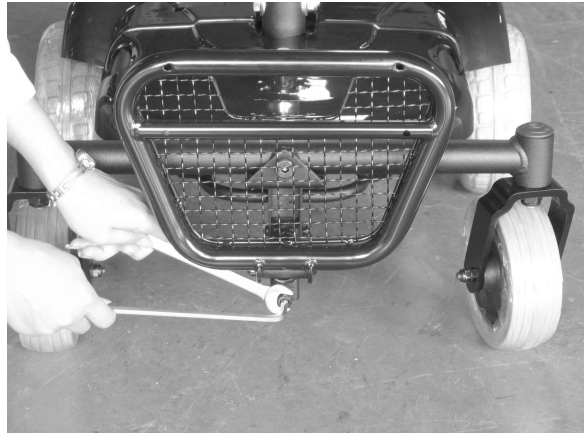

Fig G

Footplate height adjustment:

- (1) Remove the two screws, by wrench and allenkey.
- (2) Adjust the footplate to right height.
- (3) Locking the two screws.(Fig H)



Fig H

Joystick adjustment:

- (1) Loosen the knob to move the controller forward or backward.
- (2) Tighten the knob again.(Fig I)



Fig I

■ Manual Freewheel Levers:

The powerbase wheelchair has a manual freewheel lever on each motor. Manual freewheel levers enable you to disengage the drive motors from the gearboxes and maneuver the chair manually.



WARNING! Do not use the powerbase wheelchair while the drive motors are disengaged! Do not disengage the drive motors when the powerbase wheelchair is on an incline, as the unit could roll on its own, causing injury!

If a lever is difficult to move in either direction, slightly rock the powerbase wheelchair back and forth. The lever should then move to the desired position.



WARNING! It is important to remember that when your powerbase wheelchair is in freewheel mode, the braking system is disengaged.

MANUAL FREEWHEEL LEVER

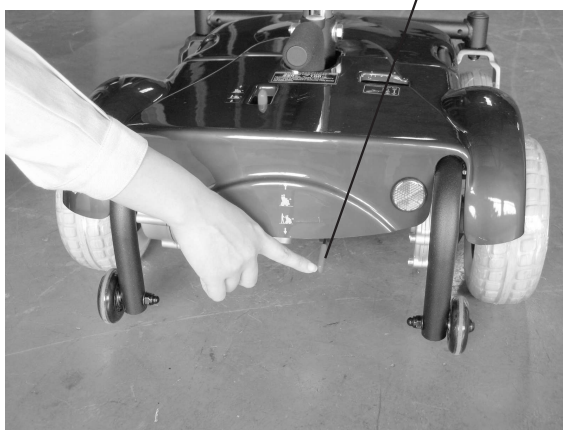

Fig J.
Move release bar downward to freewheel mode. (Left motor)



Fig K.
Move release bar backward to free wheel mode. (Right motor)

■ P&G VSI Controller Operation:

VSI Controller

The electronic controller is what you use to operate your power chair. It takes the battery voltage and sends it to the appropriate system. The electronic controller enables you to move the power chair, as well as monitor battery charge, electronic controller functions, and the conditions of your electrical system.

The VSI controller is an integral electronic controller. All of the electronics necessary to operate the power chair are contained in one module.

The VSI consists of:

1. Joystick
2. Keypad
3. Off-board charger/programming socket.
4. Motor & Battery connector

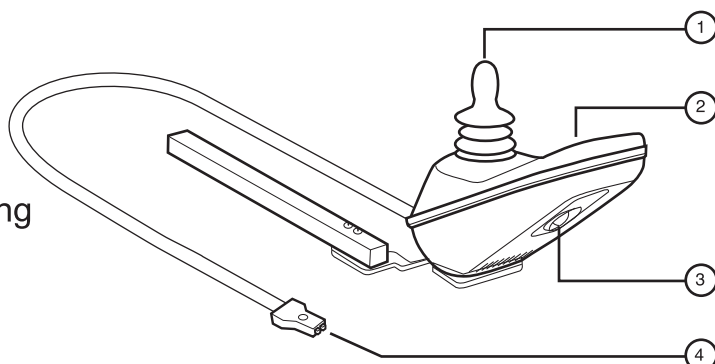

Typically, the VSI is mounted to one of the armrests and is connected to the motors and batteries.

Joystick

The joystick controls the direction and speed of your power chair. When you move the joystick from the neutral position (center), the electromagnetic brakes release and allow your power chair to move. The further you push the joystick from its neutral position, the faster the power chair moves. When you release the joystick and allow it to return to the neutral position, you engage the electromagnetic brakes. This causes the power chair to decelerate and come to a complete stop.



WARNING! If your power chair begins to move in an unexpected manner, immediately release the joystick. unless the joystick is damaged, this action should stop your power chair.

Keypad

The keypad is located on the front of the joystick.

It contains keys necessary to operate your power chair.

On/Off key

The on/off key turns the VSI on and off.

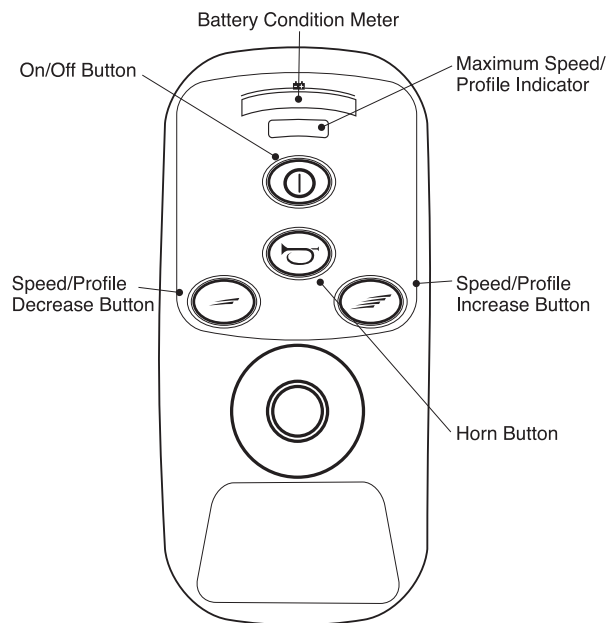

WARNING! Unless faced with an emergency situation, do not use the on/off key to stop the chair. This will cause the power chair to stop abruptly .
WARNING! Always turn the power off when you are stationary to prevent unexpected movement.

Battery Condition Meter

The battery condition meter is located in the front of the joystick. This is a 10-segment illuminated display that indicated that the VSI is turned on and also gives the battery status, the VSI status, and the electrical system status.

Red, yellow, and green lights lit: Battery charged; VSI and electrical system OK.

Red and yellow lights lit: Charge battery if possible; VSI and electrical system OK.

Red lights only lit, or slow flash: Charge battery as soon as possible; VSI and electrical system OK.

Rapid flash of lights: Indicates a fault in the VSI or the electrical system. Refer to "VSI Error Codes."

Ripple up and down lights: The joystick was not in the neutral position when the controller was turned on. If you get the "ripple up and down lights", turn off the controller, allow the joystick to return to the neutral position, then turn on the controller.

NOTE: If you still get the "ripple up and down lights", contact your Merits dealer.

NOTE: When the batteries approach a discharged state, the first red light will begin to slowly flash, reminding you the batteries need to be charged immediately.

Speed/Profile Keys

There are two keys that control either speed or the profile. This depends on how your VSI was programmed. Press the speed/profile increase key to increase the speed or change the profile. Press the speed/profile decrease key to decrease the speed or change the profile. The speed/profile setting is displayed on the maximum speed/profile indicator. If your power chair was programmed with a drive profile, contact your authorized Merits dealer to provide more information.

NOTE: We recommend that the first few times you operate your power chair, you set the speed to the slowest setting until you become familiar with your new power chair.

Horn Key

The horn key activated the horn.

Off-Board Charger/Programming Socket

You may use an off-board charger to charge the power chair batteries through the 3-pin socket located in the front of the VSI. If you use an off-board charger, the charger current should not exceed 12 amps. Contact your Merits dealer for more information.



CAUTION! Only chargers with Neutrik NC3MX plugs should be connected to the onboard charger / programming socket. See your merits dealer for more information.

Not: The socket may also be used for programming the VSI. Contact your merits dealer for more information.



CAUTION! Failure to properly align the connectors can result in damage to the controller, the charger, and the connectors.

Battery Connector

This connects the VSI to the power chair's battery box.

Motor Connector

This connects the VSI to the power chair's motors and brakes.

Thermal Rollback

The VSI controller is equipped with a thermal rollback circuit. The circuit monitors the temperature of the controller, which roughly translates to motor temperature. In the event that the VSI controller becomes excessively hot (above 140 deg. F), motor current (amperage) is reduced. For every degree above 140 deg., the motor current limit is reduced by 40 amps until the VSI controller reaches 158 deg. F., at which time the current output is reduced to zero. This reduces your chair's "power", which also could reduce your chair's speed, and allows the electrical components and motors to cool down. When the temperature returns to a safe level, your power chair resumes normal operation.

VSI Error Codes

The VSI controller is designed with the user's safety as the prime consideration. It incorporates many sophisticated self-test features which search for potential problems at a rate of 100 times per second. If the VSI detects a problem either in its own circuits or in the power chair's electrical system, it may stop the power chair, depending on the severity of the problem. The VSI is designed to maximize the user's safety under all normal conditions. The table below identifies the individual error codes. Error codes are displayed as a rapid flashing of lights. If you get one of these error codes, please contact your Merits dealer.

Flashing Lights Diagnosis/Solution

- | | |
|----|---|
| 1 | The battery needs charging, or there is a bad connection to the battery. Check the connections to the battery. If the connections are good, try changing the battery. |
| 2 | The left motor has a bad connection. Check the left motor connection. |
| 3 | The left motor has a short circuit to a battery connection. Contact your Merits dealer. |
| 4 | The right motor has a bad connection. Check the left motor connection. |
| 5 | The right motor has a short circuit to a battery connection. Contact your Merits dealer. |
| 6 | The power chair is being inhibited by the battery charger. Unplug the battery charger. |
| 7 | A joystick fault is indicated. Make sure that the joystick is in the neutral (center) position before turning on the controller. |
| 8 | A controller fault is indicated. make sure that all connections are secure. |
| 9 | The parking brakes have a ad connection. Check the parking brake and motor connections. make sure the controller system connections are secure. |
| 10 | An excessive voltage has ben applied to the controller system. This is usually caused by a poor battery connection. Check the battery connections. |

► Operating your powerbase wheelchair ◀

Batteries and Charging

Your Power Wheelchair uses two long-lasting, 12-volt batteries. These batteries are sealed, maintenance free, deep-cycle batteries. Since they are sealed, there is no need to check the electrolyte (fluid) level. Deep-cycle batteries are designed to handle a deep discharge. Though they are similar in appearance to automotive batteries, they are not interchangeable. Automotive batteries are not designed to handle a long, deep discharge, and are also unsafe for use in power wheelchairs.

WARNING! Battery posts, terminals and related accessories contain lead and lead compounds. Wash hands after handling.

BATTERY BREAK-IN

To break in your power wheelchair new batteries for maximum efficiency:

1. Fully recharge any new battery prior to initial use. This will bring the battery up to about 90% of its peak performance level.
2. Run your power wheelchair about the house and yard. Move slowly at first, and do not stray too far until you become accustomed to the controls and break in the batteries.
3. Give the batteries another full charge of 8 to 14 hours and operate the power wheelchair again. The batteries should now perform at over 90% of their potential.
4. After four or five charging cycles, the batteries will top off at 100% charge and last for an extended period.

IMPORTANT INFORMATION ABOUT BATTERIES

A fully charged deep-cycle battery provides reliable performance and extended battery life. Keep your batteries fully charged whenever possible. Batteries that are regularly discharged, infrequently charged, or stored without a full charge may be permanently damaged, causing unreliable operation and limited battery life.

If you do not use your power wheelchair regularly, we recommend maintaining battery vitality by charging the batteries at least once a week.

Note: If you are storing a power wheelchair for an extended period of time, you may wish to block the unit up off the ground with several boards under the frame. This keeps the tires off the ground to prevent the possibility of flat spots developing.

If you intend to use public transportation while using your power wheelchair, you must contact in advance the transportation provider to determine their specific requirements.

Sealed Lead Acid and Gel Cell batteries are designed for application in wheelchairs and in other mobility vehicles. Generally, Sealed Lead Acid batteries that are marked as "Non-Spill" are safe for all forms of transportation such as aircraft, buses, and trains. We suggest that you contact your transportation provider to determine specific requirements of transportation and packaging.

If you wish to use a freight company to ship the power wheelchair to your final destination, repack the power wheelchair in the original shipping container and ship its batteries in separate boxes.

Charging Your Batteries





The battery charger is one of the most important parts of your power wheelchair. Optimize your power wheelchair performance by charging the batteries safely, quickly, and easily. Use only the charger supplied with the vehicle.

Charging Procedures

1. Keep charger output plug inserted into the charging socket in the front of the controller before having the charger input plugged into an electrical outlet.
2. Follow the instructions on the front panel of the charger for operating and learn the meanings of the different indicators accordingly.
3. Minimum charging time varies depending on battery condition and discharge level. It is recommended to charge the batteries overnight.

NOTE: The specially designed charger assures that excess power is not consumed regardless of how long it is switched on, and connected to the batteries.

4. Once charging is complete, disconnect the charger from the electrical outlet and then disconnect the charger from the controller socket. Do not leave the charger connected to controller when input power is disconnected. It is dangerous and will jeopardize the power charging to the batteries.

ICE SYMBOLS	
	Caution, attention or consult accompanying documents.
	Alternating Current
	Type BF Equipment
	Double Insulation
	No Smoking or Naked Flames

Degree of protection against ingress of water is rated as IPx0.

► Warranty ◀

Limited Warranty

Corporation warrants to the original purchaser of this wheelchair product that it is free of defect in material and workmanship and that, when operated within the guidelines and restrictions of this manual, will remain so free of defect in material and workmanship for a period of One (1) year from the original date of purchase.

Excluded from this warranty is failure due to negligence, abuse, accident, operation outside of rated limits, commercial or institutional use, damage / wear to upholstery or tires and improper maintenance or storage. The batteries for this wheelchair product are not supplied by Corporation; contact the battery manufacturer / supplier if warranty replacement is requested.

This wheelchair product must not be modified in any way without the express written consent of Corporation. Any such unauthorized modification could cause unreliable and / or unsafe operation and will void this warranty.

Where a failure occurs within the 1- year warranty period that is not excluded above, the failed components will be replaced with similar new or reconditioned components at sole option. Corporation will not be responsible for labor and / or shipping charges.

The foregoing warranty is exclusive and in lieu of all other warranties expressed or implied including, but not limited to, the implied warranty of merchantability and fitness for a particular purpose. Corporation will not be liable for any consequential or incidental damages whatsoever.

We wish you a safe and comfortable riding experience!

